

- D Montageanleitung  
 E Mounting Instruction  
 HR Uputi za upotrebu  
 SLO Navodlilo za monta o kadi  
 HU Útmutató a zuhanykabin beszereléséhez  
 RO Instrucțiuni de montaj  
 CZ Návod k montá l vany  
 SK Návod na montáž  
 TR Montaj Klavuzu  
 BG Инструкции за монтаж

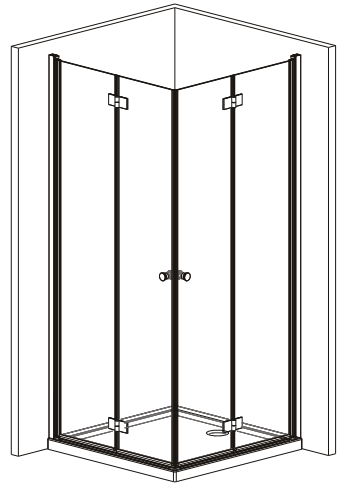

# OPTIMA

## CHROME

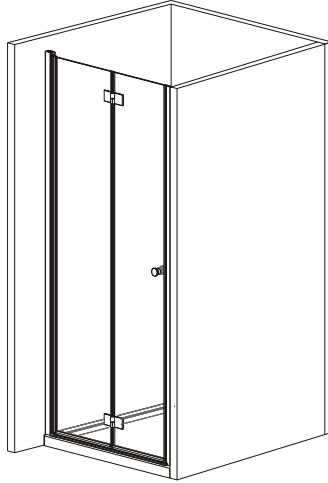

Symbol foto  
202208



**SANOTECHNIK**  
**Handelsgesellschaft m.b.H.**  
 Industriestraße 5  
 A-2752 Wöllersdorf  
 Tel.: +43 2622 / 421 93 0  
 Fax: +43 2622 / 421 93 6  
 office@sanotechnik.at  
 www.sanotechnik.com



**SANOTECHNIK Hungária Kft.**  
**MAGYARORSZÁG**  
 Nagytétényi út 112  
 H-1222 BUDAPEST  
 Tel.: (+36 1) 424 06 70  
 Fax: (+36 1) 424 06 79  
 info@sanotechnik.hu  
 www.sanotechnik.com



**SC Sanotechnik COM Rumänien S.R.L.**  
**ROMANIA**  
 Tancabesti, DN 1, KM 26,5  
 Com. Snagov, jud. Ilfov  
 Tel.: +40 21 350 13 43  
 Fax: +40 21 350 13 44  
 office@sanotechnik.ro  
 www.sanotechnik.com



**SANOTECHNIK d.o.o.**  
**SLOVENIJA**  
 Stritarjeva ulica 24  
 SI-2000 MARIBOR  
 Tel. +3862/4213350  
 Fax +3862/4213358  
 info@sanotechnik.si  
 www.sanotechnik.com





**Sanotechnik Bulgaria Ltd.**  
**BULGARIA**  
 3, Georgi Benev St.  
 BG-4003 Plovdiv  
 Tel: +359 32 961101  
 Fax: +359 32 961102  
 office@sanotechnik.bg  
 www.sanotechnik.com

**SANOTECHNIK**<sup>®</sup>  
 INTERNATIONAL

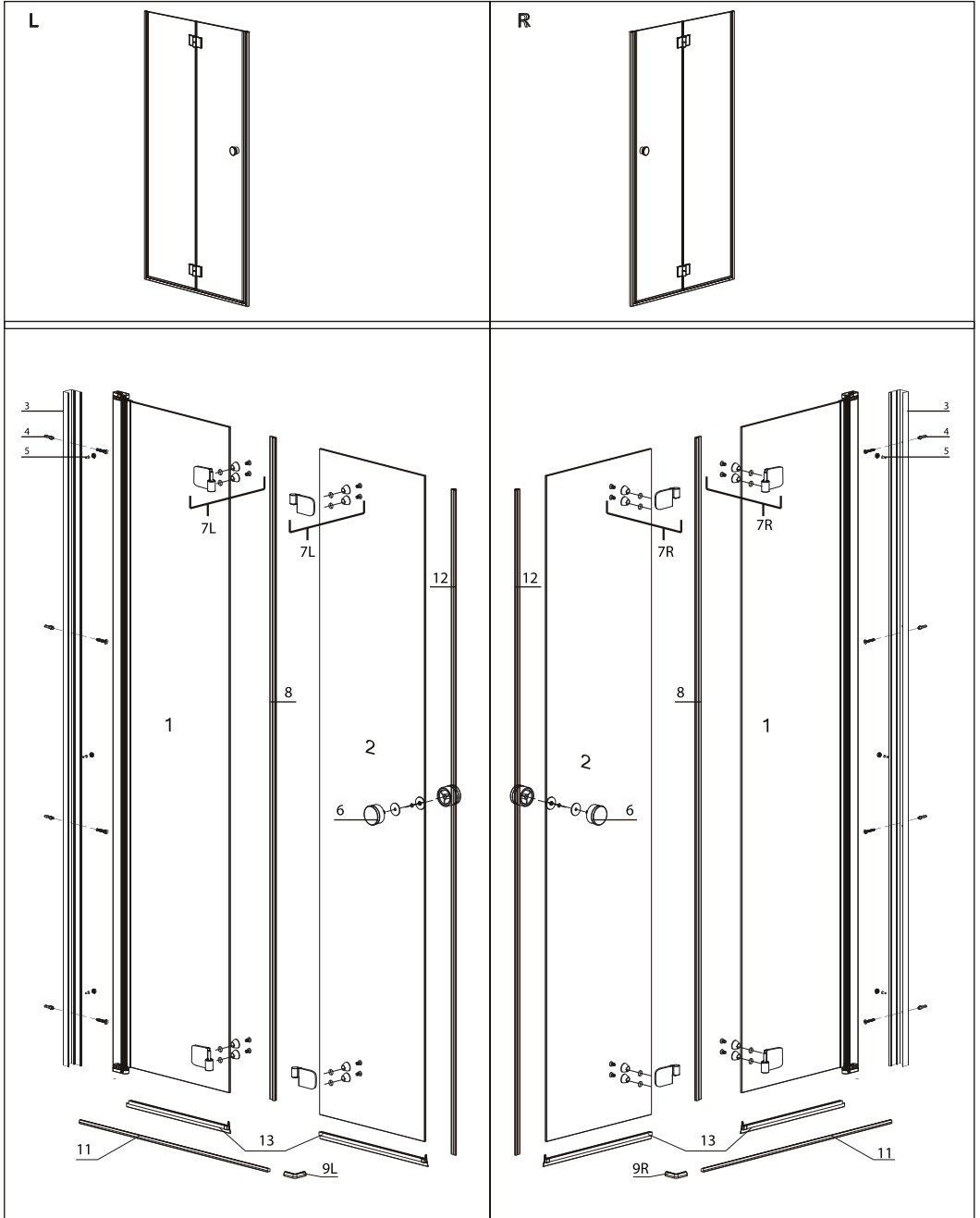
◆ Assembly Drawing

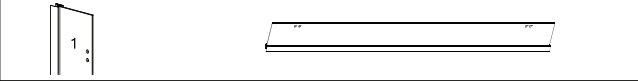
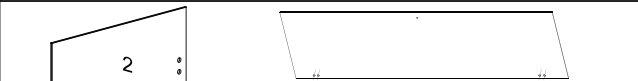
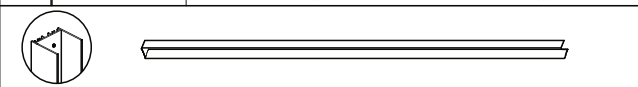
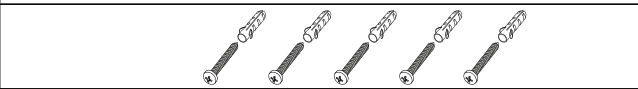

# ◆ Box Contents

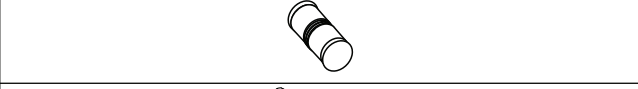
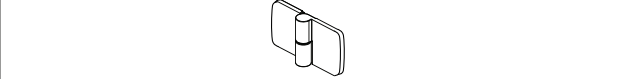
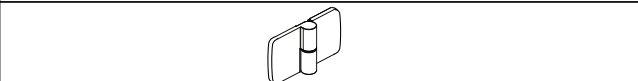
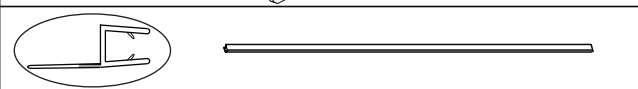
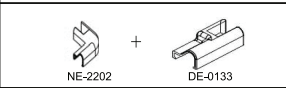
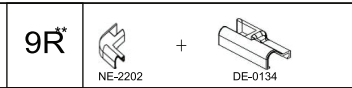
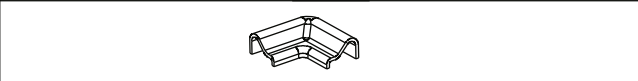
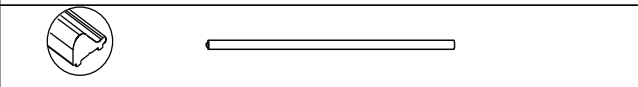
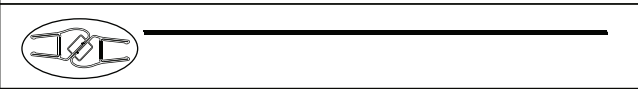
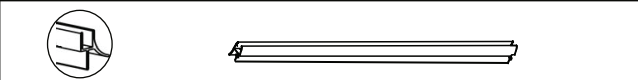
1			X1
2			X1
3	NE-1704		X1
4	DE-0138		X5
5	DE-0137		X3
6	NE-0901		X1
7L*	HY1B-L		X2
7R**	HY1B-R		X2
8	DE-0156		X1
9L*		9R* 	X1
10	NE-2201		X1
11	NE-1719		X1
12	NE-2304		X1
13	NE-2409		X1

\*only for left enclosures  
\*\*only for right enclosures

# ◆ Installation Steps

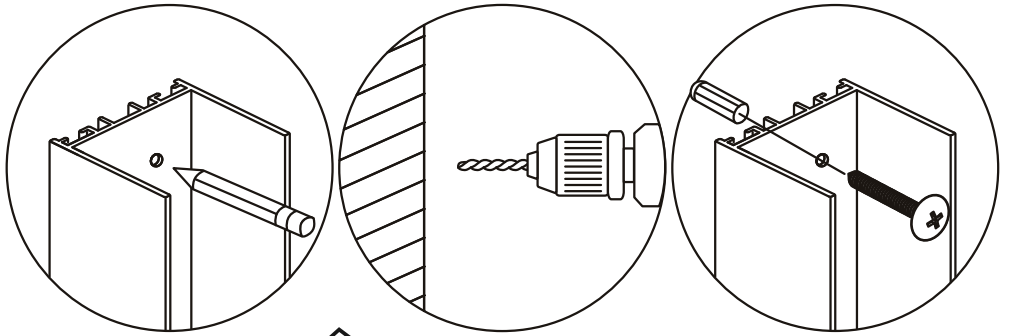

**1**

**2**

K/L	800/800	900/900	1000/1000
X	73-75	83-85	93-95
Y	73-75	83-85	93-95

